

주식회사 제코

EXPANSION JOINT

교량용 신축이음장치

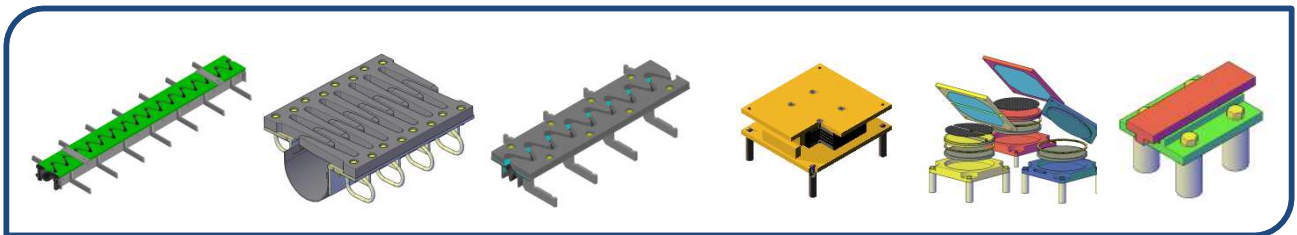

MAS  나라장터 종합쇼핑몰 등록업체

내진보강 전단키

포트발침, 탄성발침

건축용 포트발침

인증 및 특허 현황

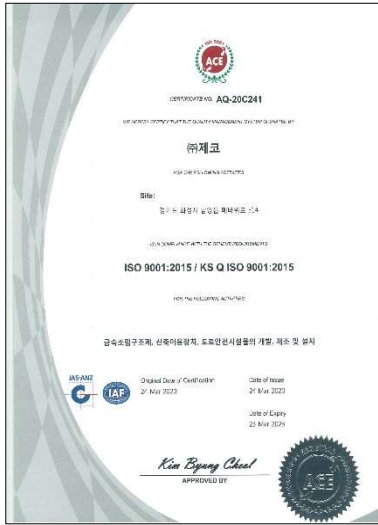

ISO인증서

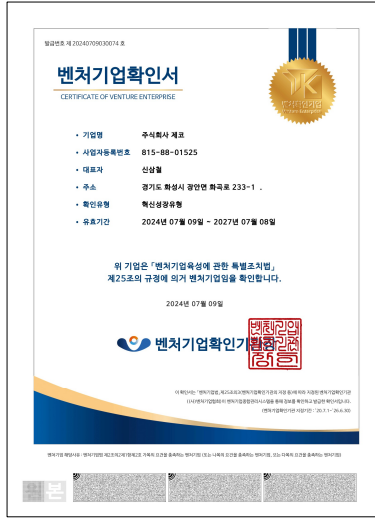

벤처기업확인서



연구개발전담부서 인정서

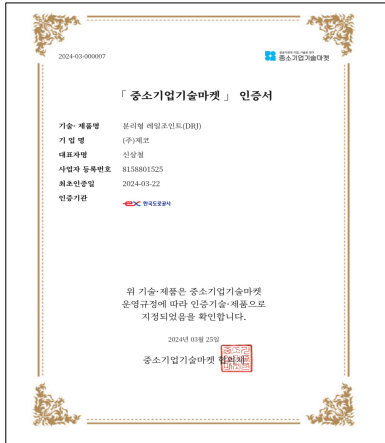

중소기업기술마켓 인증서

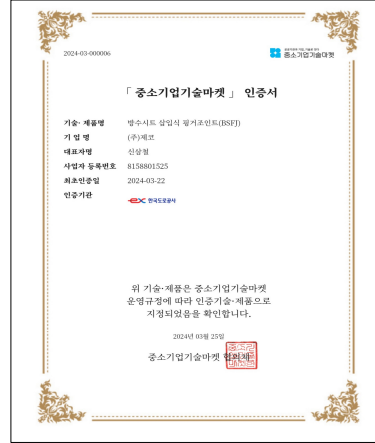

중소기업기술마켓 인증서



디자인등록증



특허증



특허증



특허증

뉴모노셀 조인트

 나라장터종합쇼핑몰 등록제품

	모델명	ZNMC-30B
	규격	1790x95x112
	식별번호	26214999
	조달단가	275,000원/m

	모델명	ZNMC-35B
	규격	1790x97x112
	식별번호	26215000
	조달단가	295,000원/m

	모델명	ZNMC-50
	규격	1800x412x112
	식별번호	25463370
	조달단가	305,000원/m

	모델명	ZNMC-60B
	규격	1790x105x112
	식별번호	26215001
	조달단가	325,000원/m

	모델명	ZNMC-80
	규격	1800x427x112
	식별번호	25463372
	조달단가	352,000원/m

	모델명	ZNMC-100B
	규격	1750x125x112
	식별번호	26215002
	조달단가	526,000원/m

뉴모노셀 중조인트

 나라장터종합쇼핑몰 등록제품

	모델명	ZLMC-20B
	규격	1790x95x112
	식별번호	26214997
	조달단가	265,000원/m

	모델명	ZLMC-35B
	규격	1790x100x112
	식별번호	26214998
	조달단가	270,000원/m

뉴핑거 조인트

 나라장터종합쇼핑몰 등록제품

	모델명	ZNFJ-30B
	규격	1790x160x116
	식별번호	26215003
	조달단가	389,000원/m

	모델명	ZNFJ-35B
	규격	1790x162x116
	식별번호	26215004
	조달단가	390,000원/m

	모델명	ZC-NFJ-50B
	규격	1800x165x16t
	식별번호	24229876
	조달단가	456,000원/m

	모델명	ZC-NFJ-80B
	규격	1800x210x16t
	식별번호	24229877
	조달단가	681,000원/m

	모델명	ZC-NFJ-100B
	규격	1800x240x19t
	식별번호	24229878
	조달단가	749,000원/m

	모델명	ZC-NFJ-120B
	규격	1800x270x19t
	식별번호	24229879
	조달단가	930,000원/m

	모델명	ZNFJ-160
	규격	1800x778x124
	식별번호	25463399
	조달단가	1,050,000원/m

분리형 레일 조인트  나라장터종합쇼핑몰 등록제품

	모델명	DRJ-30B
	규격	1800x105x114
	식별번호	26215008
	조달단가	420,000원/m

	모델명	DRJ-50
	규격	1800x492x114
	식별번호	25463401
	조달단가	425,000원/m

	모델명	DRJ-80B
	규격	1800x120x114
	식별번호	26215009
	조달단가	430,000원/m

	모델명	DRJ-100B
	규격	1800x130x114
	식별번호	26215010
	조달단가	435,000원/m

BSFJ 강핑거 조인트  나라장터종합쇼핑몰 등록제품

	모델명	BSFJ-50B
	규격	1000x205x118
	식별번호	26215011
	조달단가	600,000원/m

	모델명	BSFJ-80B
	규격	1000x242x124
	식별번호	26215012
	조달단가	850,000원/m

	모델명	BSFJ-100
	규격	995x540x125
	식별번호	25463406
	조달단가	890,000원/m

	모델명	BSFJ-120B
	규격	1000x310x131
	식별번호	26215013
	조달단가	1,050,000원/m

	모델명	BSFJ-150B
	규격	1000x375x141
	식별번호	26215014
	조달단가	1,750,000원/m

	모델명	BSFJ-160B
	규격	1000x390x141
	식별번호	26215015
	조달단가	1,950,000원/m

	모델명	BSFJ-200B
	규격	1000x480x141
	식별번호	26215016
	조달단가	2,285,000원/m

	모델명	BSFJ-240
	규격	995x846x173
	식별번호	25463411
	조달단가	2,500,000원/m

	모델명	BSFJ-250B
	규격	1000x565x175
	식별번호	26215017
	조달단가	2,550,000원/m

	모델명	BSFJ-300
	규격	995x955x230
	식별번호	25463413
	조달단가	3,110,000원/m

	모델명	BSFJ-320B
	규격	1000x670x230
	식별번호	26215018
	조달단가	3,200,000원/m

	모델명	BSFJ-350B
	규격	1000x745x240
	식별번호	26215019
	조달단가	3,280,000원/m

	모델명	BSFJ-400B
	규격	1000x820x240
	식별번호	26215020
	조달단가	4,150,000원/m

이중배수형 강핑거 조인트  나라장터종합쇼핑몰 등록제품

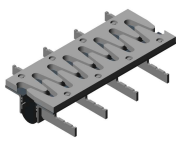
	모델명	DWFJ-160B
	규격	1000x390x141
	식별번호	26215021
	조달단가	1,980,000원/m

	모델명	DWFJ-200B
	규격	1000x480x141
	식별번호	26215022
	조달단가	2,380,000원/m

	모델명	DWFJ-240B
	규격	1000x550x175
	식별번호	26215023
	조달단가	2,600,000원/m

	모델명	DWFJ-250B
	규격	1000x565x175
	식별번호	26215024
	조달단가	2,650,000원/m

	모델명	DWFJ-300
	규격	995x955x230
	식별번호	25463421
	조달단가	3,210,000원/m

	모델명	DWFJ-320B
	규격	1000x670x230
	식별번호	26215025
	조달단가	3,320,000원/m

	모델명	DWFJ-350B
	규격	1000x745x240
	식별번호	26215026
	조달단가	3,400,000원/m

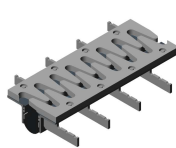
	모델명	DWFJ-400B
	규격	1000x820x240
	식별번호	26215027
	조달단가	4,250,000원/m

메모 :

뉴모노셀 조인트

조달청분류번호 : 3012171501

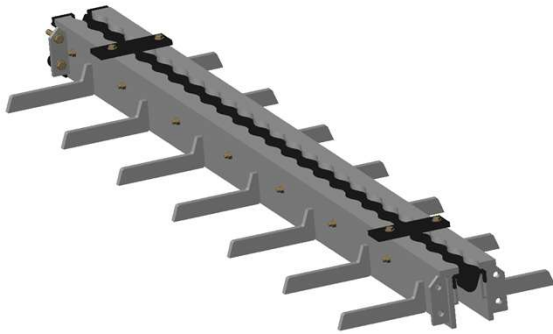

● 뉴모노셀 조인트(NMC)

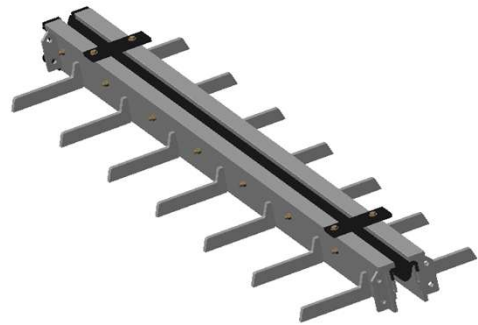

● 뉴모노셀 중조인트(LMC)

뉴모노셀 조인트의 특징

- 상판이 웨이브형태의 구조로서 주행성과 저소음성이 유리하다.
- 직교, 사교, 곡선교 등 모든 교량에 적용이 가능함.
- 1.8M 이상 주문길이로 제작 가능함.
- 최적화 설계로 내구성이 우수하다.

뉴모노셀 조인트 제원표 (30~100)

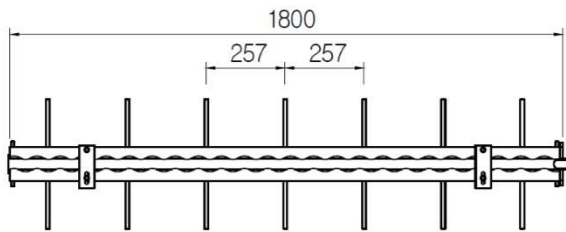

평 면 도

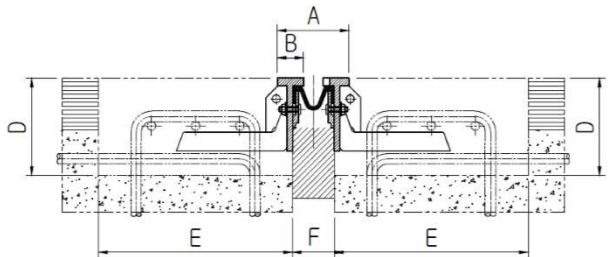

단 면 도

단위:mm

모델명	최대 신축량	A	B	BLOCK OUT		F (유간)			중량 (kg/m)	식별번호
				D	E	Min.	Mid.	Max.		
ZNMC-30B	30	95	40	150	270	25	40	55	32	26214999
ZNMC-35B	35	97	40	150	270	25	43	60	32	26215000
ZNMC-50	50	100	40	150	270	25	50	75	32	25463370
ZNMC-60B	60	105	40	150	270	25	55	85	32	26215001
ZNMC-80	80	115	40	150	270	25	65	105	33	25463372
ZNMC-100B	100	125	40	150	270	25	75	125	33	26215002
ZLMC-20B	20	95	40	150	270	25	40	55	32	26214997
ZLMC-35B	35	100	40	150	270	25	50	75	32	26214998

뉴핑거 조인트

조달청분류번호 : 3012171501



뉴핑거 조인트의 특징

- 불연속부를 최소화한 구조로서 주행성과 저소음성이 탁월하다.
- 직교, 사교, 곡선교 등 모든 교량에 적용이 가능함.
- 1.8M 이상 주문길이로 제작 가능함.
- 최적화 설계로 내구성이 우수하다.

뉴핑거 조인트 제원표 (30~160)

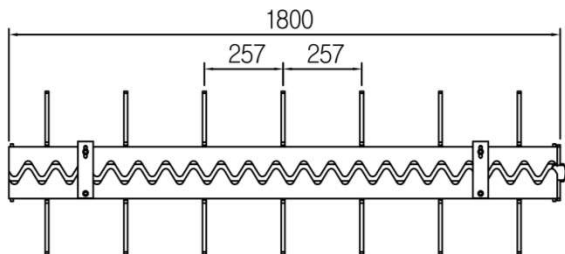

평 면 도

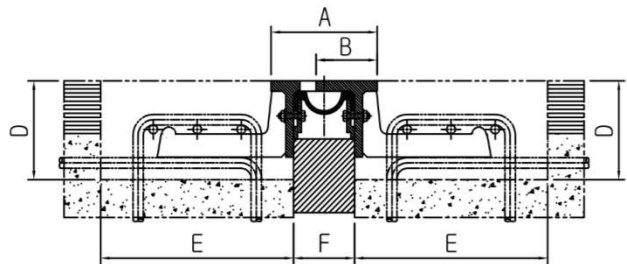

단 면 도

단위:mm

모델명	최대 신축량	A	B	BLOCK OUT		F (유간)			중량 (kg/m)	식별번호
				D	E	Min.	Mid.	Max.		
ZNFJ-30B	30	160	95	150	300	35	50	65	42	26215003
ZNFJ-35B	35	162	95	150	300	35	52	70	42	26215004
ZC-NFJ-50B	50	165	95	150	300	60	85	110	43	24229876
ZC-NFJ-80B	80	210	125	150	300	80	120	160	57	24229877
ZC-NFJ-100B	100	240	145	150	300	100	150	200	64	24229878
ZC-NFJ-120B	120	270	165	180	350	120	180	240	73	24229879
ZNFJ-160	160	340	210	180	350	160	240	320	90	25463399

분리형 레일 조인트

(중소기업기술마켓 인증제품)

분리형 레일조인트 특징

- 교량의 폭에 맞게 일체형으로 제작하여 방수성능이 우수함.
- 직교, 사교, 곡선교 외 강상판교 등 모든 교량에 적용이 가능함.
- 일체형과 분리형의 장점만을 적용한 신개념 레일 조인트임.

분리형 레일조인트 특징점

- 7중 방수시스템+클램프 디바이스 적용으로 완벽한 방수성능 확보.
- 상판 분리방식으로 쉽고 빠른 고무실 교체와 상부플레이트의 교체 등 후타의 손상이 없어 유지보수비용의 획기적 절감.

◆ 특허 제10-2042954호

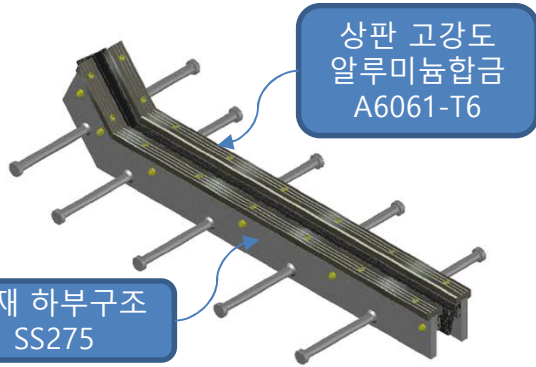

분리형 레일조인트

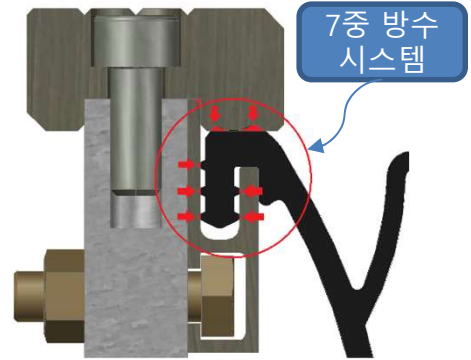

7중 방수 시스템

분리형 레일 조인트 제원표 (타입 50~100)

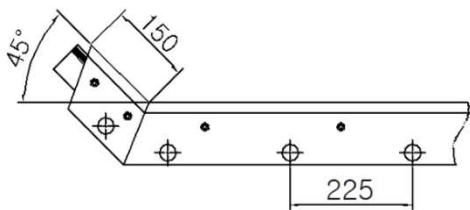

측면도

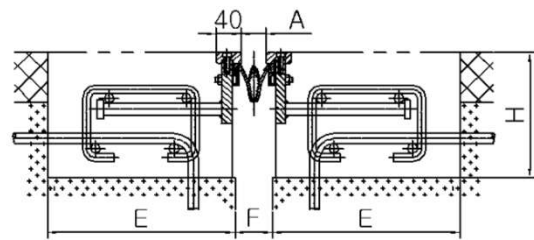

단면도

단위:mm

모델명	최대 신축량	A	BLOCK OUT		F(유간)			중량 (kg/m)	식별번호
			H	E	Min.	Mid.	Max.		
DRJ-50	50	30	200	300	20	45	70	34	25463401
DRJ-80B	80	40	200	300	40	60	120	34	26215009
DRJ-100B	100	50	200	300	50	70	150	34	26215010

BSFJ 핑거 조인트

(중소기업기술마켓 인증제품)

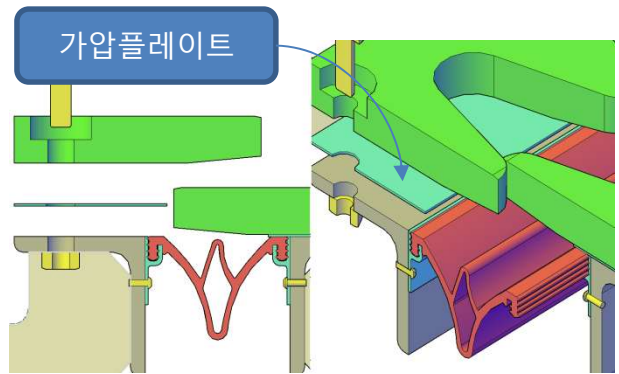
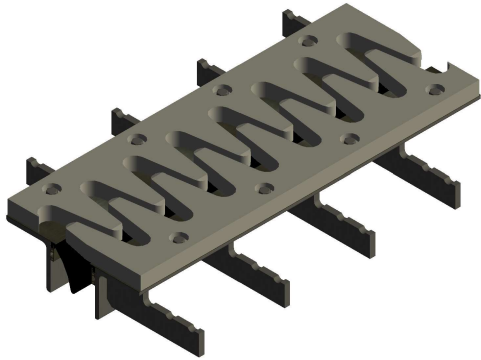

BSFJ 핑거 조인트 특징

- 저소음과 주행성이 우수하다.
- 직교, 사교, 곡선교 외 강상판교 등 모든 교량에 적용이 가능함.
- 고무셀 클램프 디바이스를 별도 적용해 우수한 방수성능 확보
- 간단히 고무셀 교체 가능

방수성능 및 클린기능

- 고무셀 클램프 디바이스와 고무셀 가압 플레이트를 추가 적용하여 방수 성능 확보와 험프타입 고무셀의 신축작용으로 이물질의 원활한 배출을 유도합니다.

◆ 특허 제10-2042954호

BSFJ 핑거 조인트 제원표

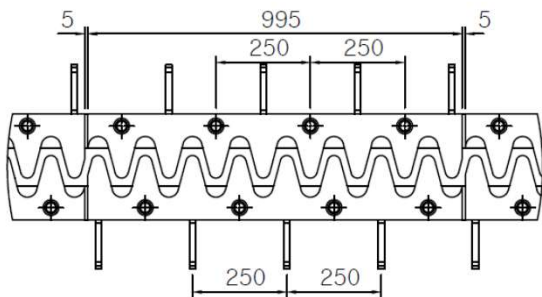

평 면 도

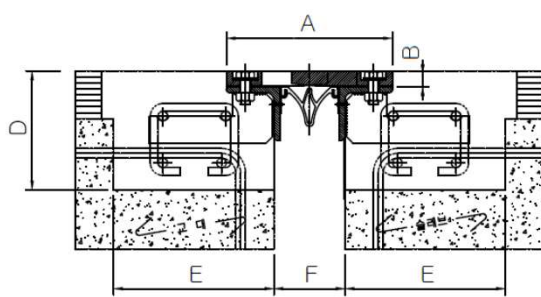

단 면 도

단위:mm

모델명	최대 신축량	A	B	BLOCK OUT		F (유간)			중량 (kg/m)	식별번호
				D	E	Min.	Mid.	Max.		
BSFJ-50B	50	205	25	200	240	65	90	115	64	26215011
BSFJ-80B	80	242	30	200	250	70	110	150	80	26215012
BSFJ-100	100	280	30	200	270	70	120	170	94	25463406
BSFJ-120B	120	310	32	200	290	76	136	196	115	26215013
BSFJ-150B	150	375	40	200	290	65	140	215	155	26215014
BSFJ-160B	160	390	40	200	320	74	154	234	163	26215015
BSFJ-200B	200	480	45	250	320	110	210	310	227	26215016
BSFJ-240	240	550	50	250	320	120	240	360	260	25463411
BSFJ-250B	250	565	50	300	320	120	245	370	276	26215017
BSFJ-300	300	640	55	300	320	170	320	470	306	25463413
BSFJ-320B	320	670	55	300	320	190	350	510	350	26215018
BSFJ-350B	350	745	60	320	330	210	385	560	405	26215019
BSFJ-400B	400	820	65	320	330	200	400	600	445	26215020

이중배수 핑거 조인트

(중소기업기술마켓 인증제품)

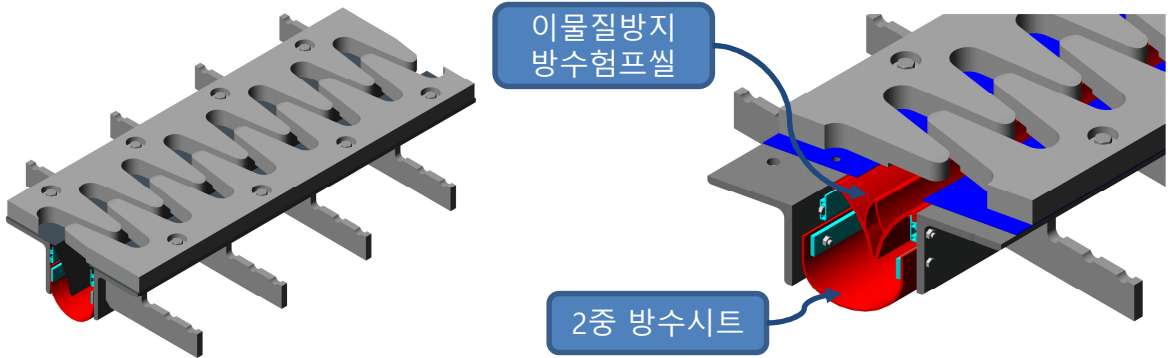

이중배수 핑거 조인트 특징

- 저소음과 주행성이 우수하다.
- 직교, 사교, 곡선교 외 강상판교 등 모든 교량에 적용이 가능함.
- 이물질방지 방수 헴프셀과 하부 배수판의 이중배수 타입으로 방수성능 극대화.
- 상부 삽입식의 이물질방지 고무셀 적용으로 유지보수성 향상.
- 7중 방수시스템과 가압판 적용으로 우수한 1차 방수성능.

◆ 특허 제10-2042954호

이중배수 핑거 조인트 제원표

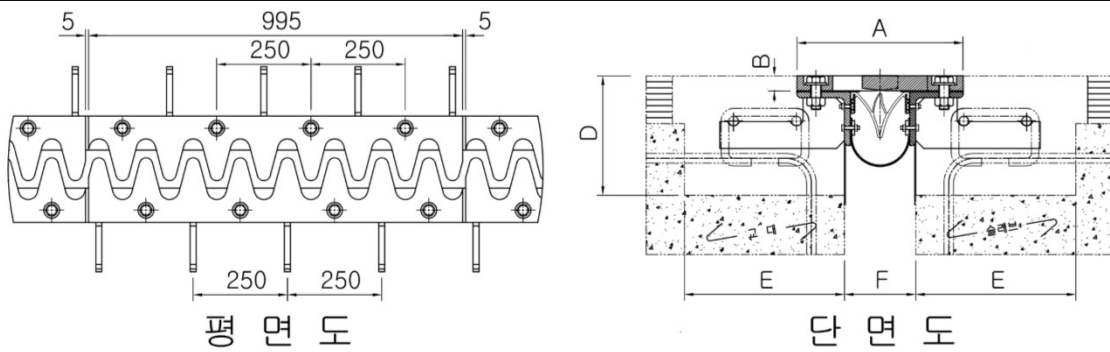

단위:mm

모델명	최대 신축량	A	B	BLOCK OUT		F (유간)			중량 (kg/m)	식별번호
				D	E	Min.	Mid.	Max.		
DWFJ-160B	160	390	40	200	320	74	154	234	163	26215021
DWFJ-200B	200	480	45	250	320	110	210	310	227	26215022
DWFJ-240B	240	550	50	250	320	120	240	360	260	26215023
DWFJ-250B	250	565	50	300	320	120	245	370	276	26215024
DWFJ-300	300	640	55	300	320	170	320	470	306	25463421
DWFJ-320B	320	670	55	300	320	190	350	510	350	26215025
DWFJ-350B	350	745	60	320	330	210	385	560	405	26215026
DWFJ-400B	400	820	65	320	330	200	400	600	445	26215027

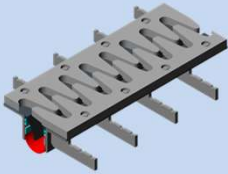

이물질방지
이중배수핑거조인트
(특허 제 10-2042954 호)

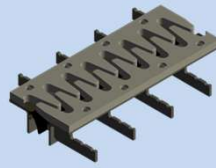

BSFJ 핑거조인트
(특허 제 10-2042954 호)

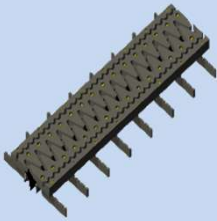

가변신축핑거조인트
(특허 제 10-2041736 호)
(특허 제 10-2042954 호)

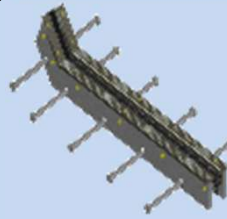

분리형 레일 조인트
(특허 제 10-2042954 호)

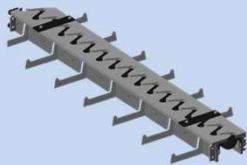

뉴핑거조인트

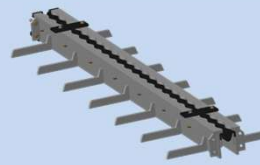

뉴모노셀조인트

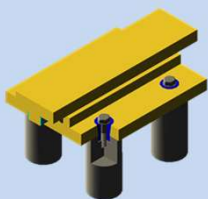

내진보강 전단키
(특허 제 10-23008044호)

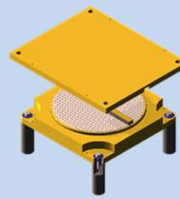

교량용 포트받침
건축용 포트받침
특허 제 10-23008044호)

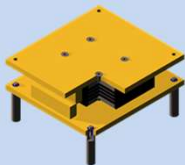

일체형 탄성받침
특허 제 10-23008044호)

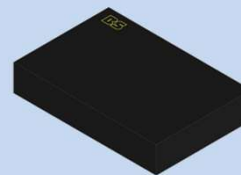

콘크리트전단키용
방진패드

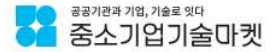

경기도 화성시 장안면 화곡로 233-1

bszeco@gmail.com

TEL : 070-8615-5117 FAX : 031-624-8117

www.bszeco.co.kr